

Numéro de page	Titre de la page	Date	Indice
1	Page de garde	20/11/2023	A
2	Liste des pages	20/11/2023	A
3	Implantation TGBT	20/11/2023	A
4	Schéma électrique	20/11/2023	A
5	Liste de matériel	20/11/2023	A

A

B

C

D

E

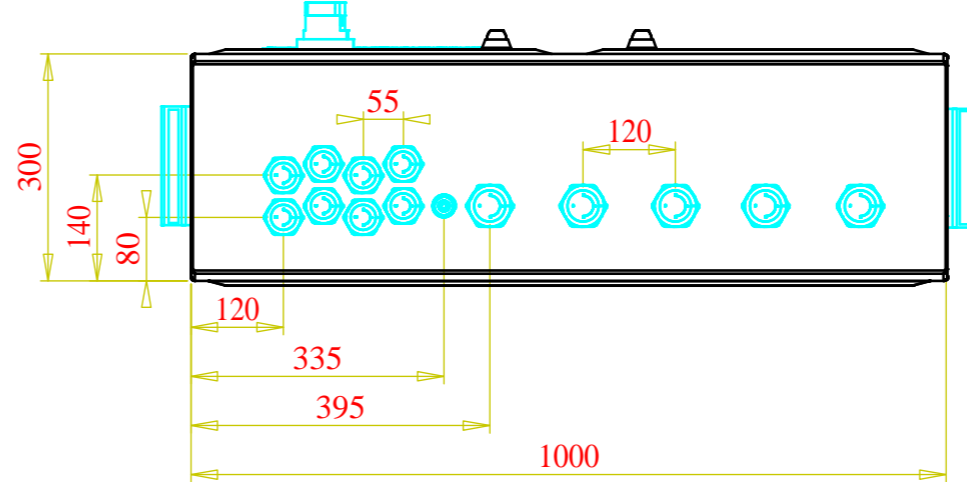
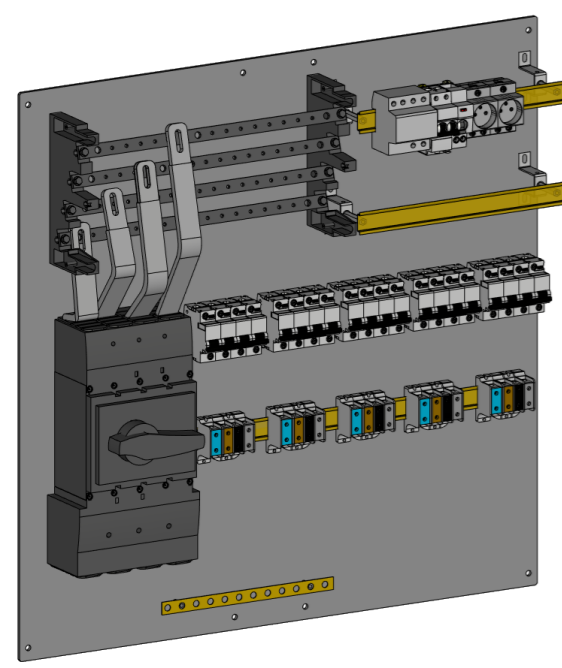
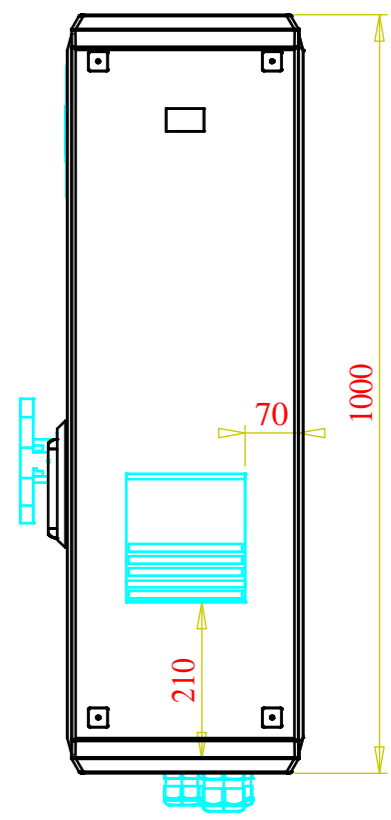
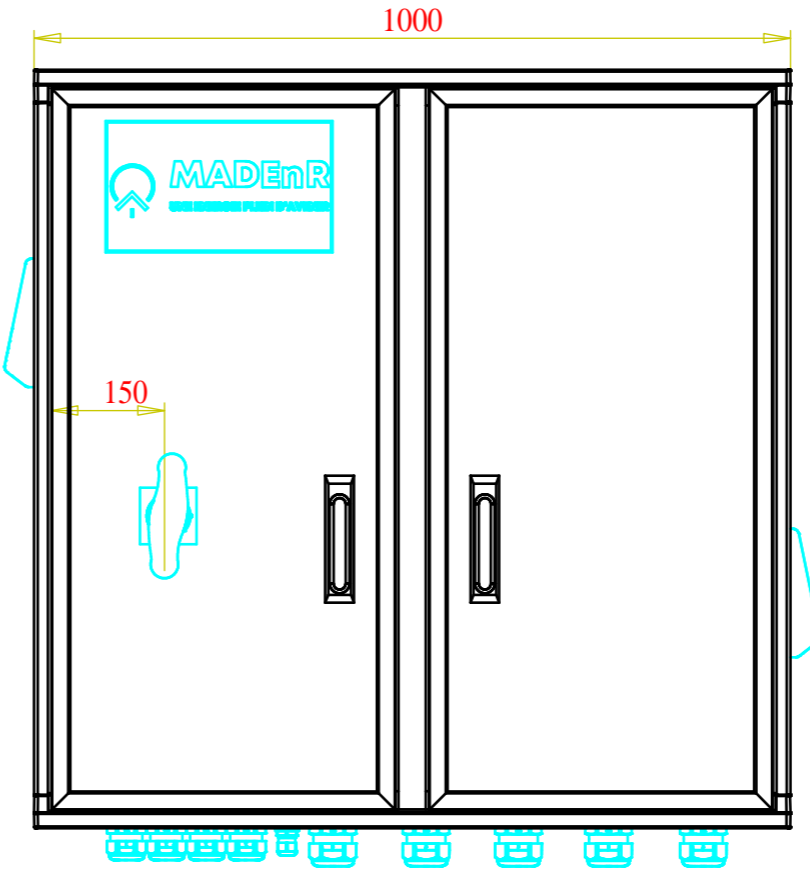
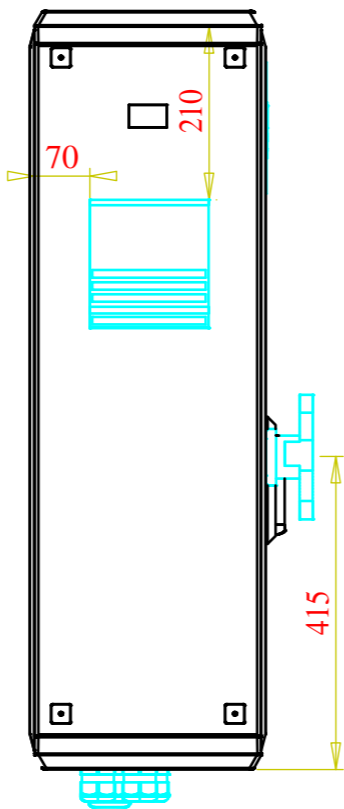
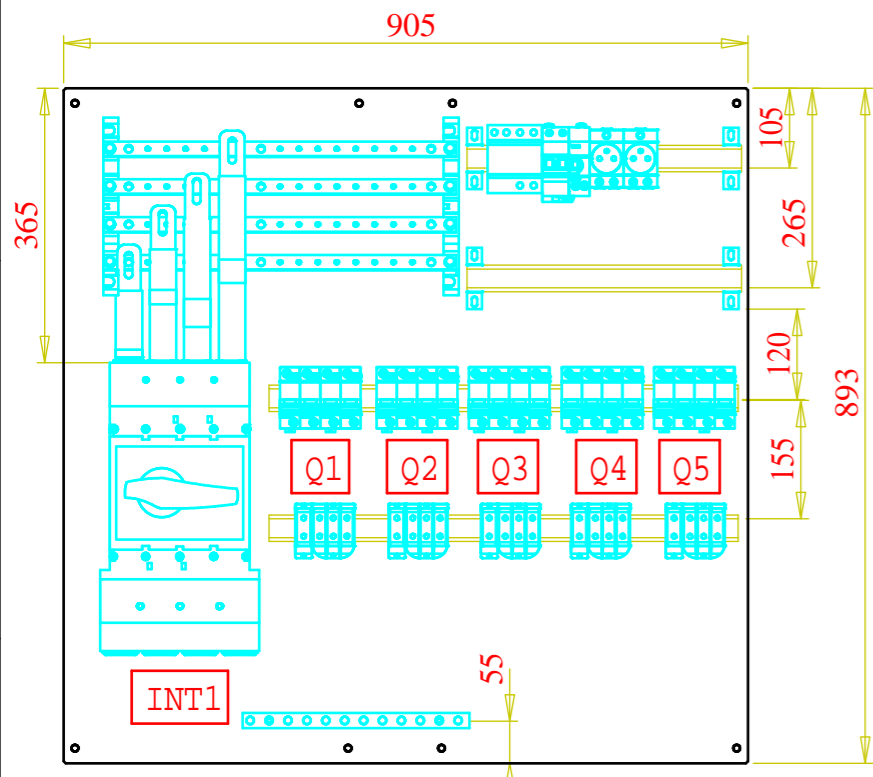

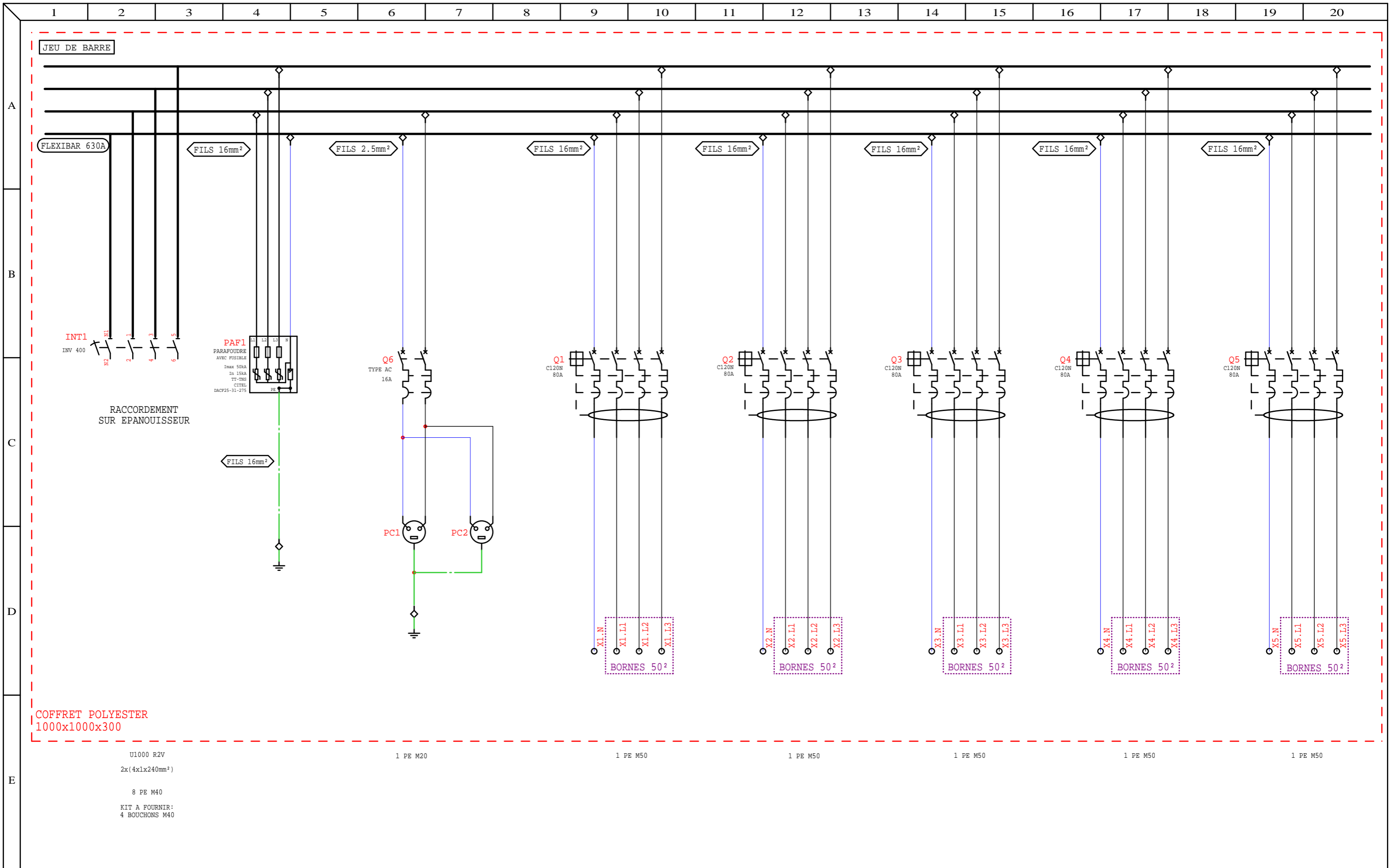

Repère	Description	Fournisseur	Folio
INT1	Interrupteur-sectionneur INV400 Compact - 4 pôles - 400A	SCHNEIDER	4
PAF1	PARAFONDRE 3P+N IN 15KA IMAX 50KA	CITEL	4
PC1	Ex9DS-F	Noark	4
PC2	Ex9DS-F	Noark	4
Q1	C120N 4P 80A C 10kA 415V	SCHNEIDER	4
Q2	C120N 4P 80A C 10kA 415V	SCHNEIDER	4
Q3	C120N 4P 80A C 10kA 415V	SCHNEIDER	4
Q4	C120N 4P 80A C 10kA 415V	SCHNEIDER	4
Q5	C120N 4P 80A C 10kA 415V	SCHNEIDER	4
Q6	Disjoncteur, Acti9 iC60N, 2P, 16 A, courbe C, 10 Ka	SCHNEIDER	4
Q6	Acti9, Vigi iC60, bloc différentiel 2P 25A 30mA type AC 230-240V 400-415V	SCHNEIDER	4
X1.L1	Borne 50mm2 3P Marron/noire/grise	HORAETEC	4
X1.N	Borne 50mm2 Bleue	HORAETEC	4
X2.L1	Borne 50mm2 3P Marron/noire/grise	HORAETEC	4
X2.N	Borne 50mm2 Bleue	HORAETEC	4
X3.L1	Borne 50mm2 3P Marron/noire/grise	HORAETEC	4
X3.N	Borne 50mm2 Bleue	HORAETEC	4
X4.L1	Borne 50mm2 3P Marron/noire/grise	HORAETEC	4
X4.N	Borne 50mm2 Bleue	HORAETEC	4
X5.L1	Borne 50mm2 3P Marron/noire/grise	HORAETEC	4
X5.N	Borne 50mm2 Bleue	HORAETEC	4



Siège social :
 2 avenue du Gros Chêne
 95610 ÉRAGNY-SUR-OISE
 Usine de production :
 20 avenue Marcel LIABASTRE
 14600 HONFLEUR
 Tel : 02 31 65 59 40
 Internet: www.madnr.com

Titre du dossier / Project title :
 Coffret AC TRI 5 OND 250kW (5x80A)

Titre du folio / Page title
 Liste de matériel

No d'affaire / Project number FBPAT541E		Ind. / Revision A
Concepteur / Designer DH	Date 20/11/2023	Folio / Page 5
Client / Customer		Précédent / Previous 4
		Suivant / Next /